

Varenummer: 20167B252SW  
 Beskrivelse: E+G  
 Bred fod holder GN167-B25-2-SW

## Mål

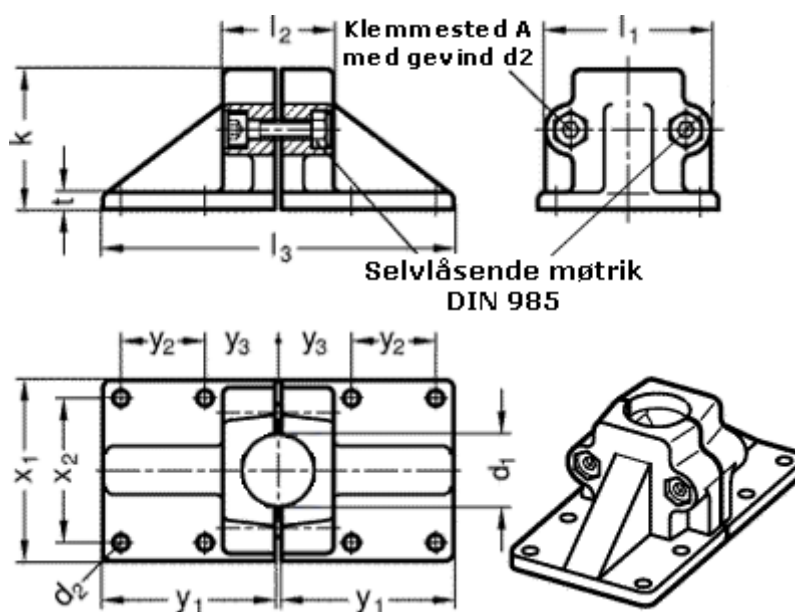

$d1 = B25$	$x1 = 75$
$d2 = 7$	$x2 = 60$
$d3 = M 8$	$y1 = 72$
$k = 58$	$y2 = 35$
$l1 = 69$	$y3 = 30$
$l2 = 46$	
$l3 = 146$	
$t = 7$	